

(別紙 )

## イ号物件目録

防災平板瓦、商品名「ReCeRa」(リセラ)。但し別紙図面の形状の物。

平面图

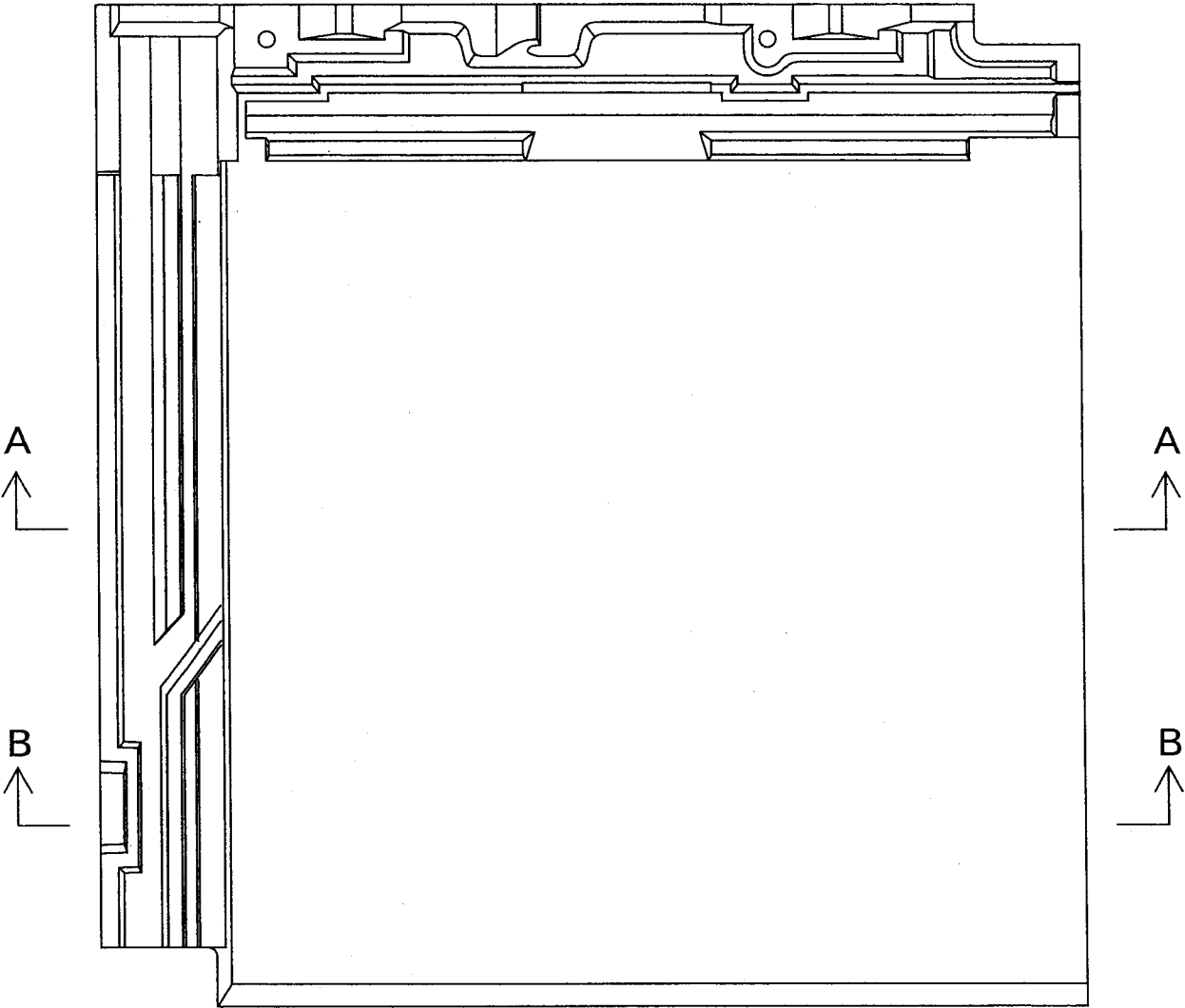

底面图

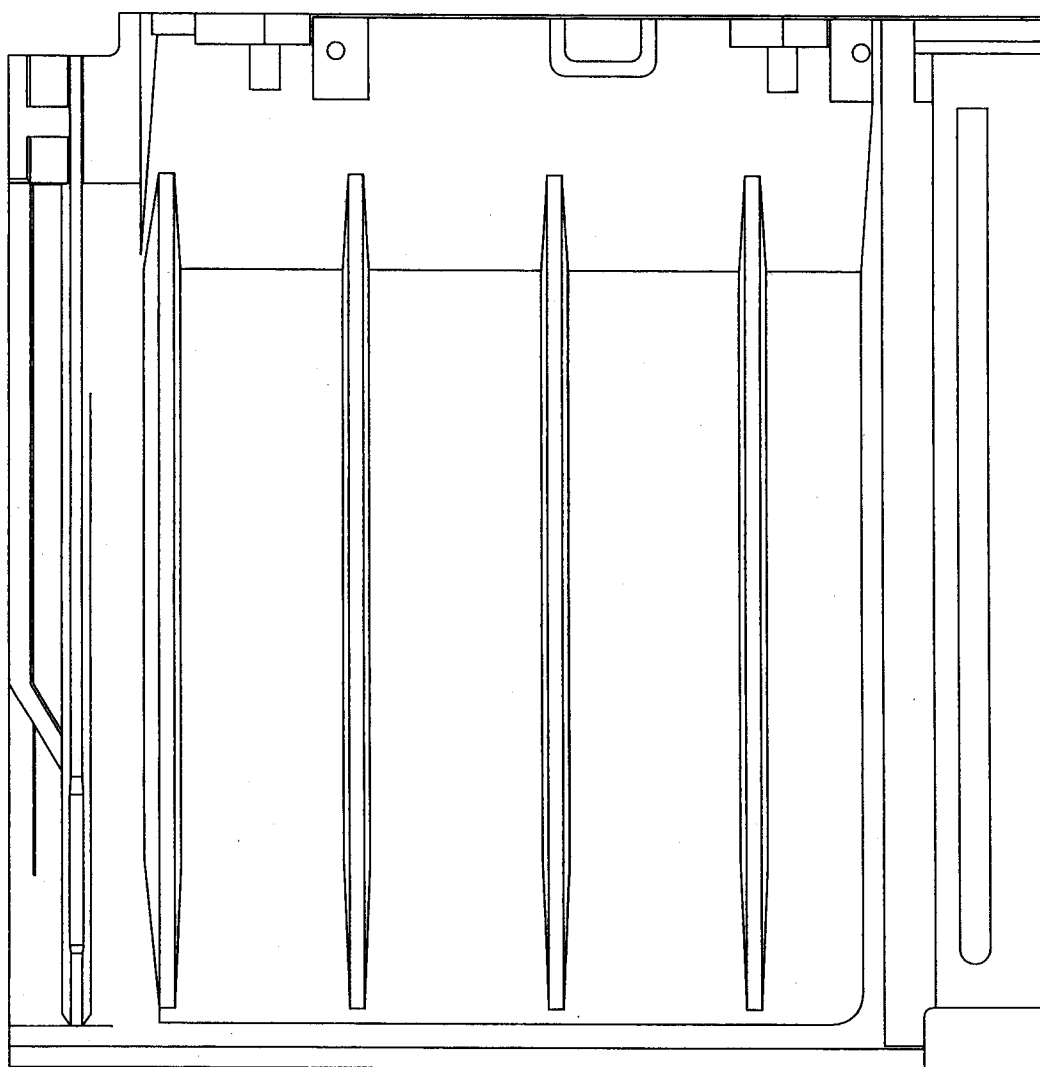

正面图

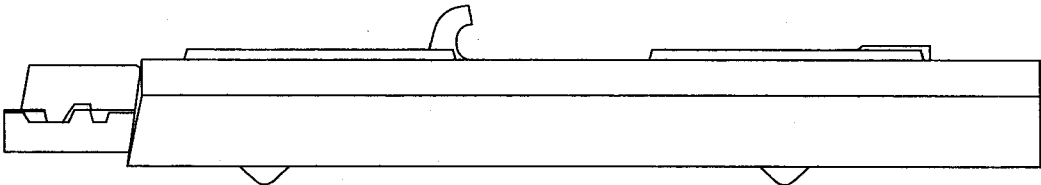

背面图

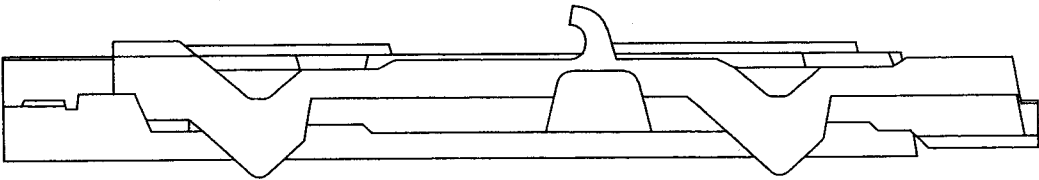

右側面図

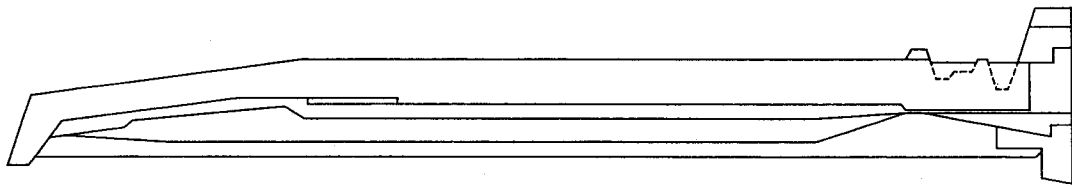

左側面図

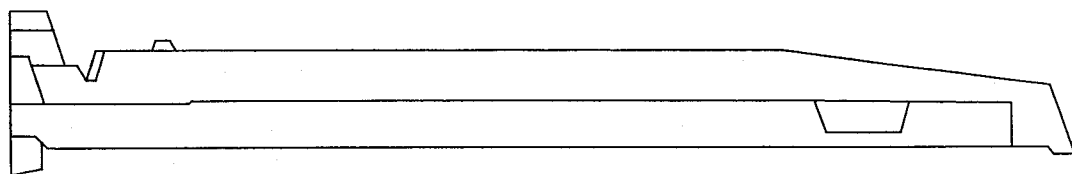

A - A 断面图

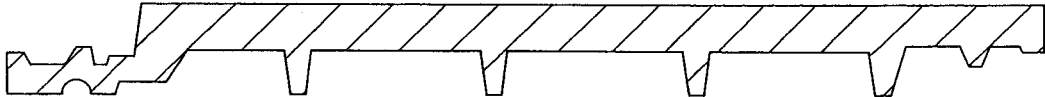



B - B 断面图

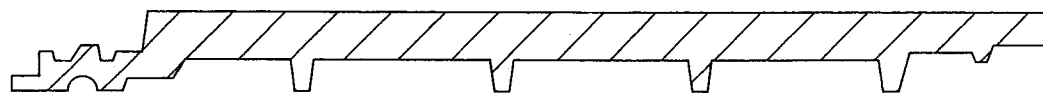

イ号物件係合凸部



側面

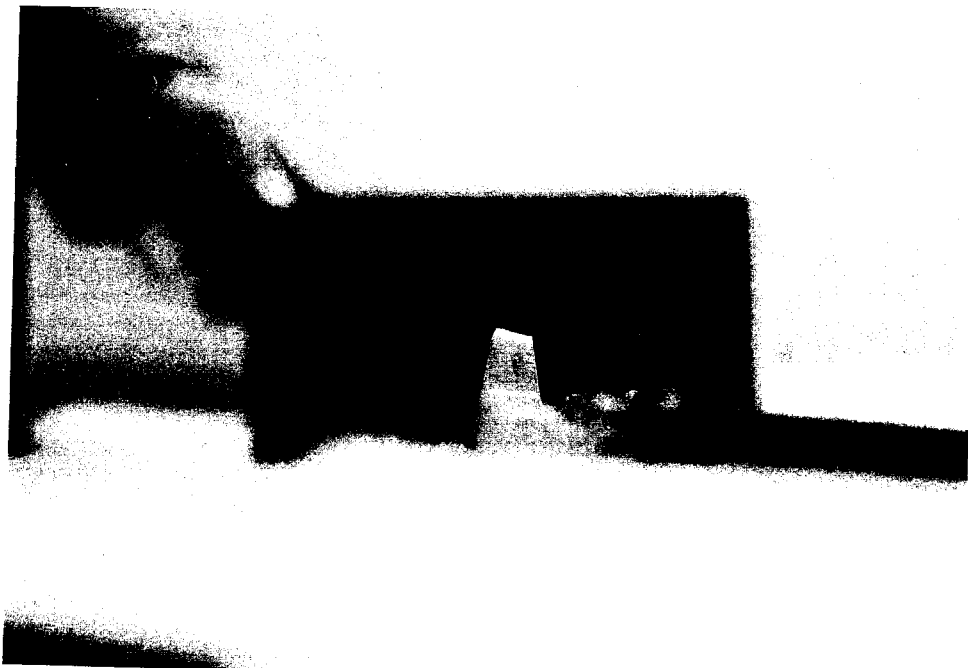

側面

イ号物件係合凸部

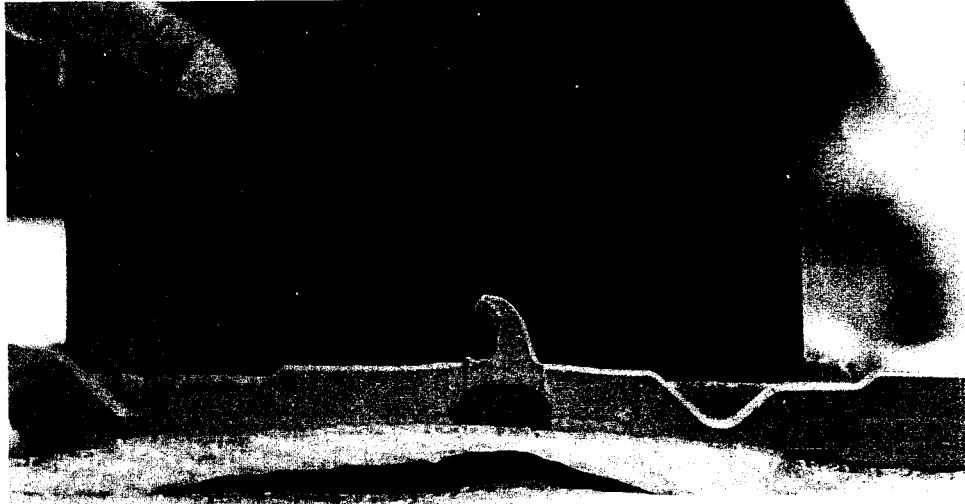

尻側



頭側

(別紙 )

# 「イ号 係合凸部」

イ号

## 係合凸部

左側面図

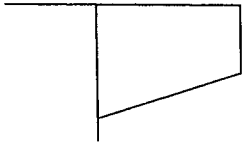

正面図

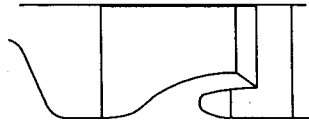

右側面図

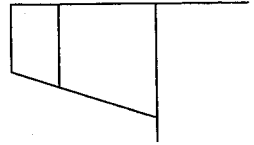

底面図

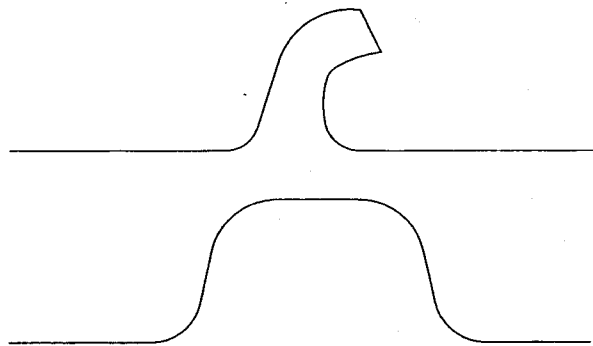

(別紙 )

## ハ号物件目録

防災平瓦、商品名「ReCeRa You」(リセラ ユー)、但しS形瓦を除く。

平面図

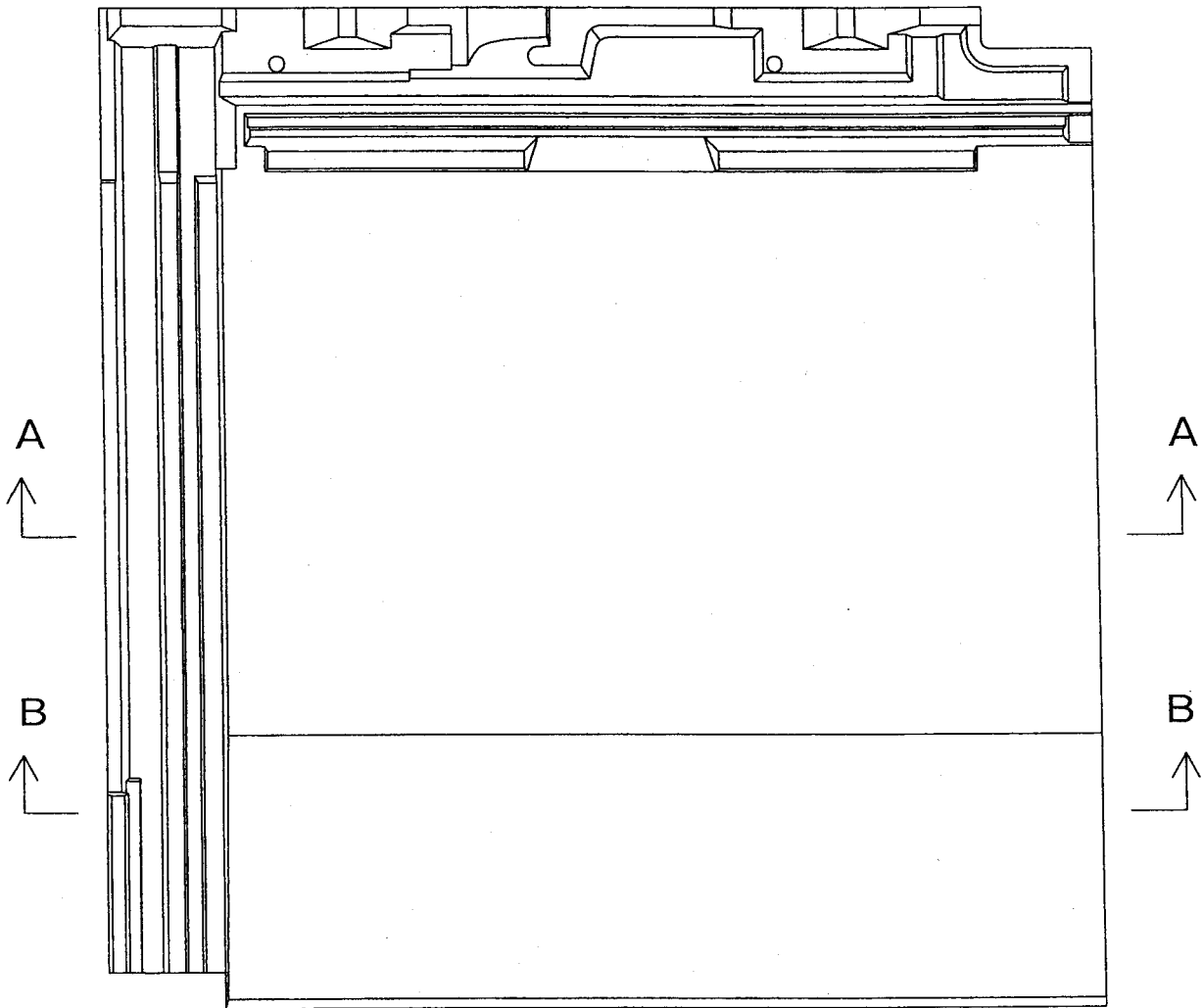

底面图

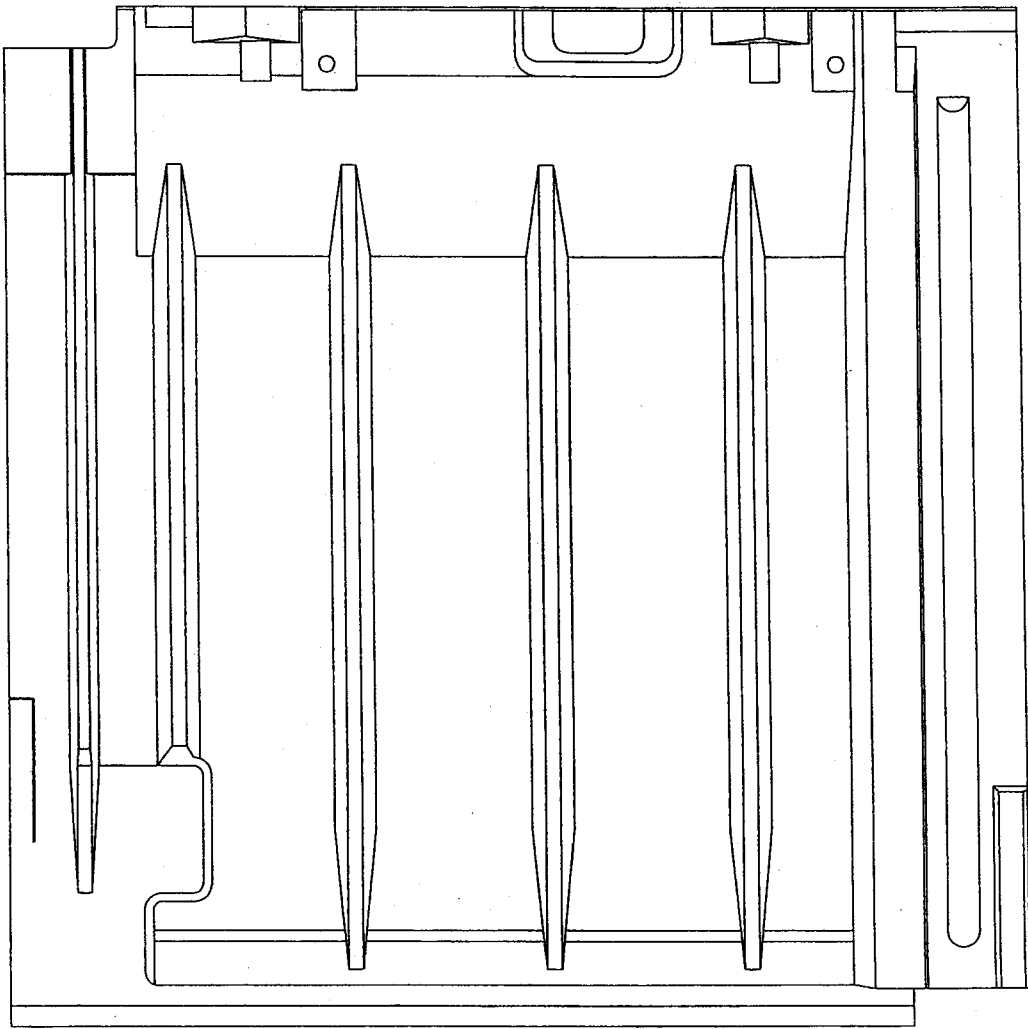

正面図

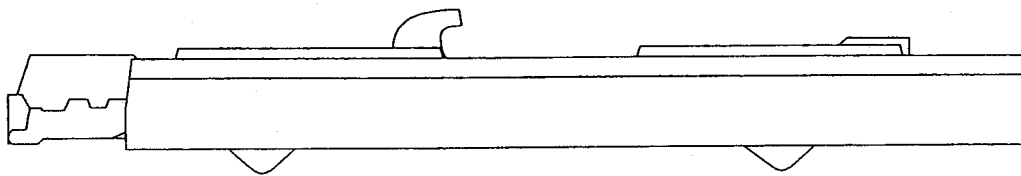



背面图

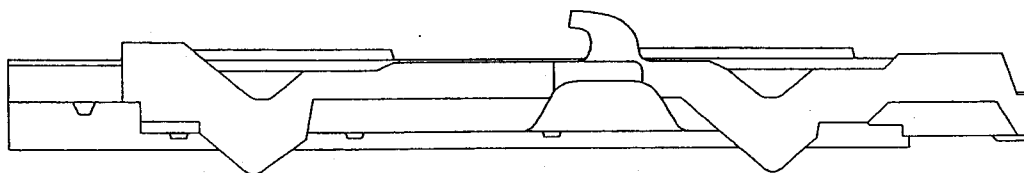

右側面図

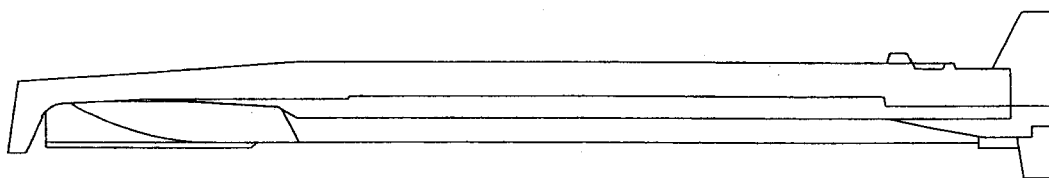

左側面図

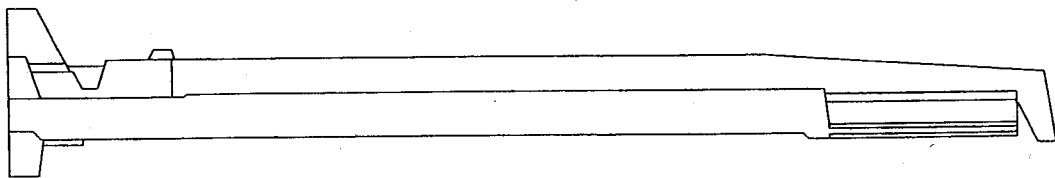

A-A 断面图

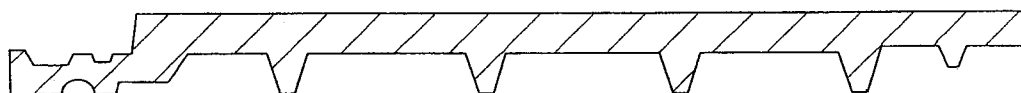

B—B断面图

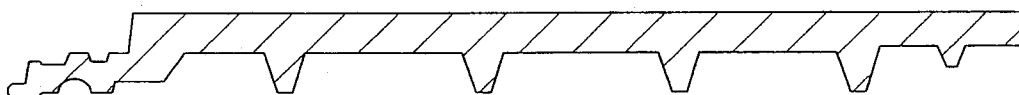

(別紙

)

# 八号物件係合凸部

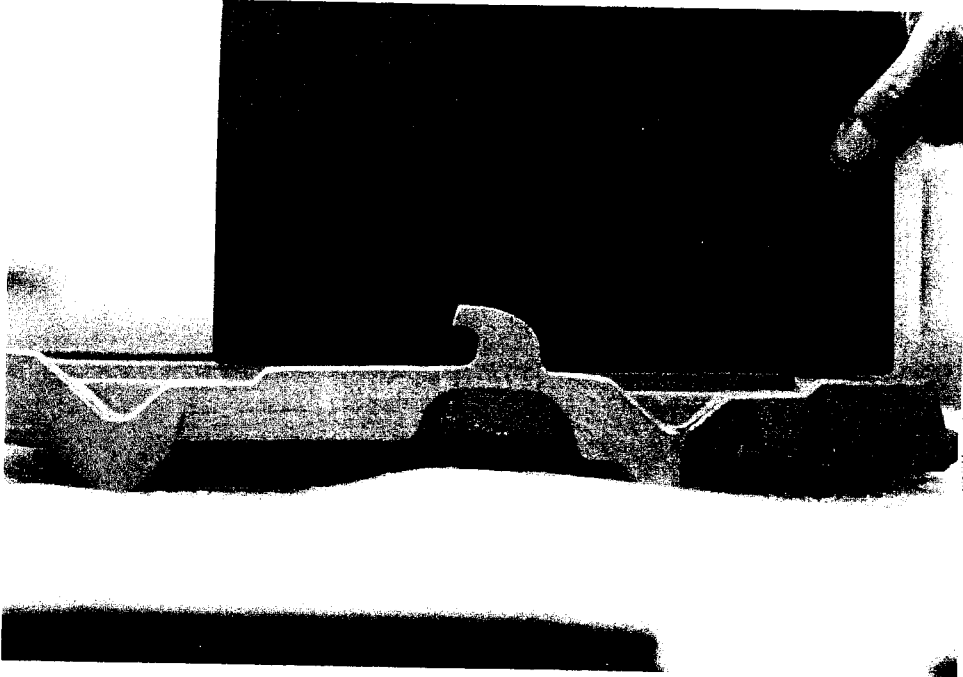

尻側



頭側

八号物件係合凸部

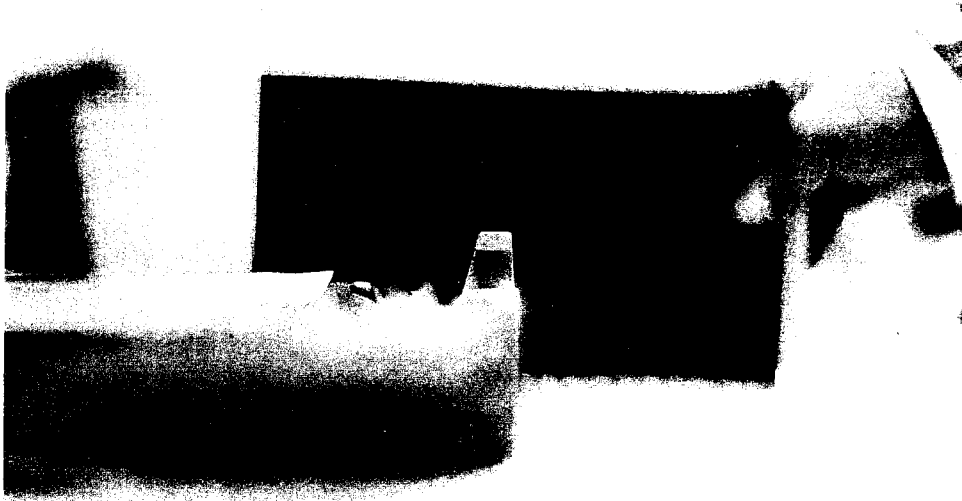

側面

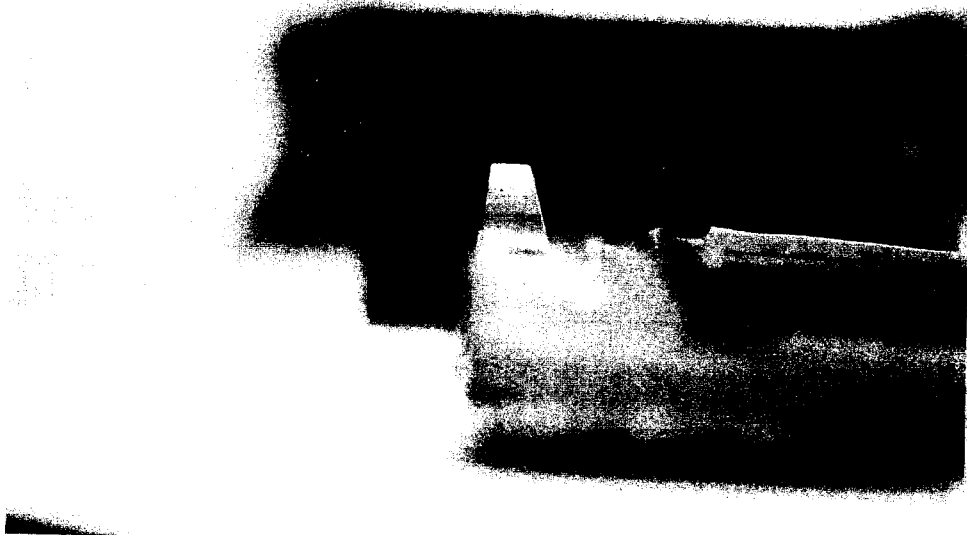

側面

(別紙 )

「八号 係合凸部」

八号

係合凸部

左側面図

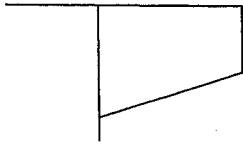

正面図

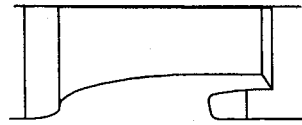

右側面図

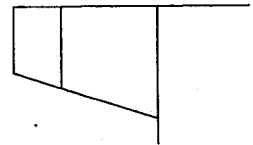

底面図

