

## 被告商品目録

商品名を「夢見るかかとちゃん」と称する角質除去具であって、写真のとおり形状を有するもの。

写真

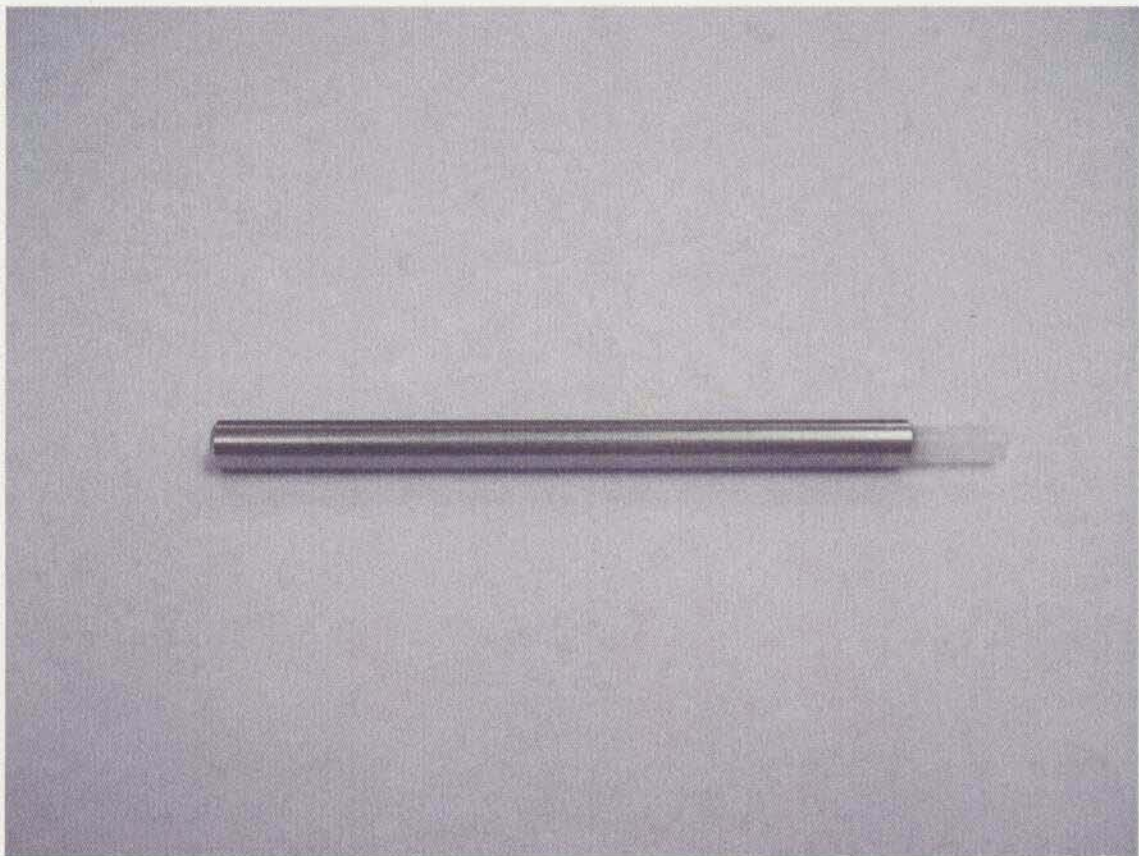

# 被告商品図面

図面1 (被告円筒管と被告スティックとが組み合わさった状態)

(平面図)



(左側面図)



(正面図)



(右側面図)



(斜視図)

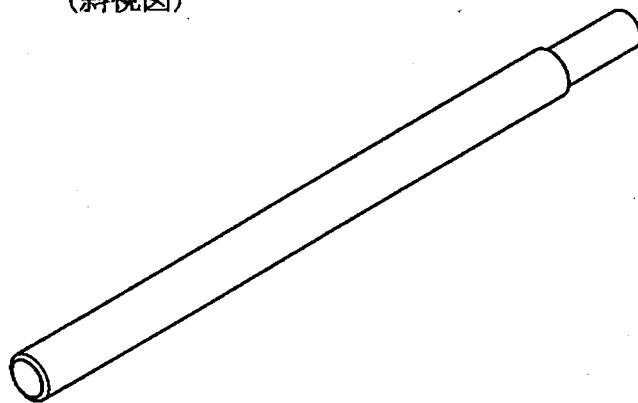

図面 2 (被告円筒管)

(平面図)



(側面図)



(正面図)



(斜視図)

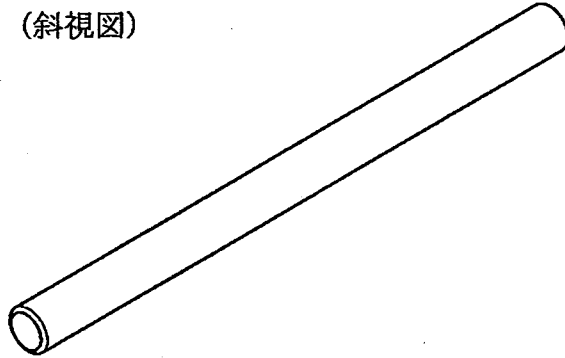

図面 3 (被告スティック)

(平面図)

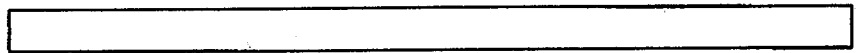

(側面図)



(正面図)



(斜視図)

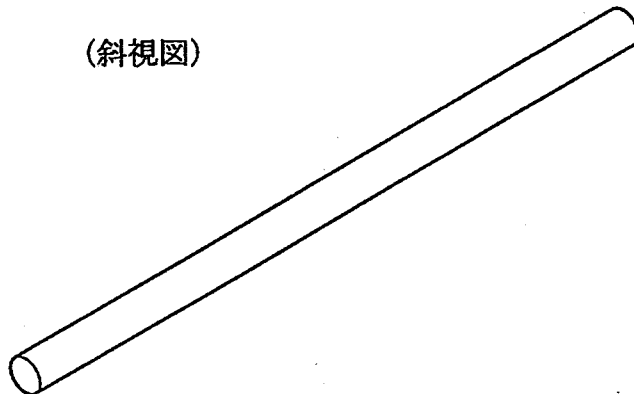

図面 4 (被告円筒管一刃先拡大図)

(正面図)

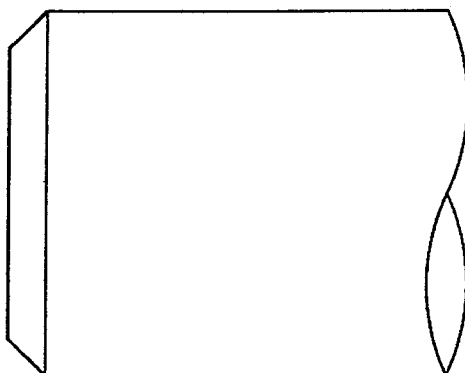

(正面図・断面図)

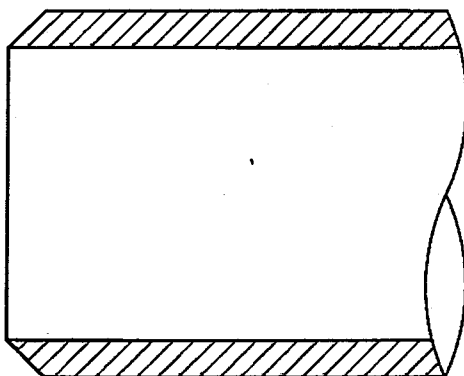

図面 5 (被告商品のパッケージ内での収納状態)

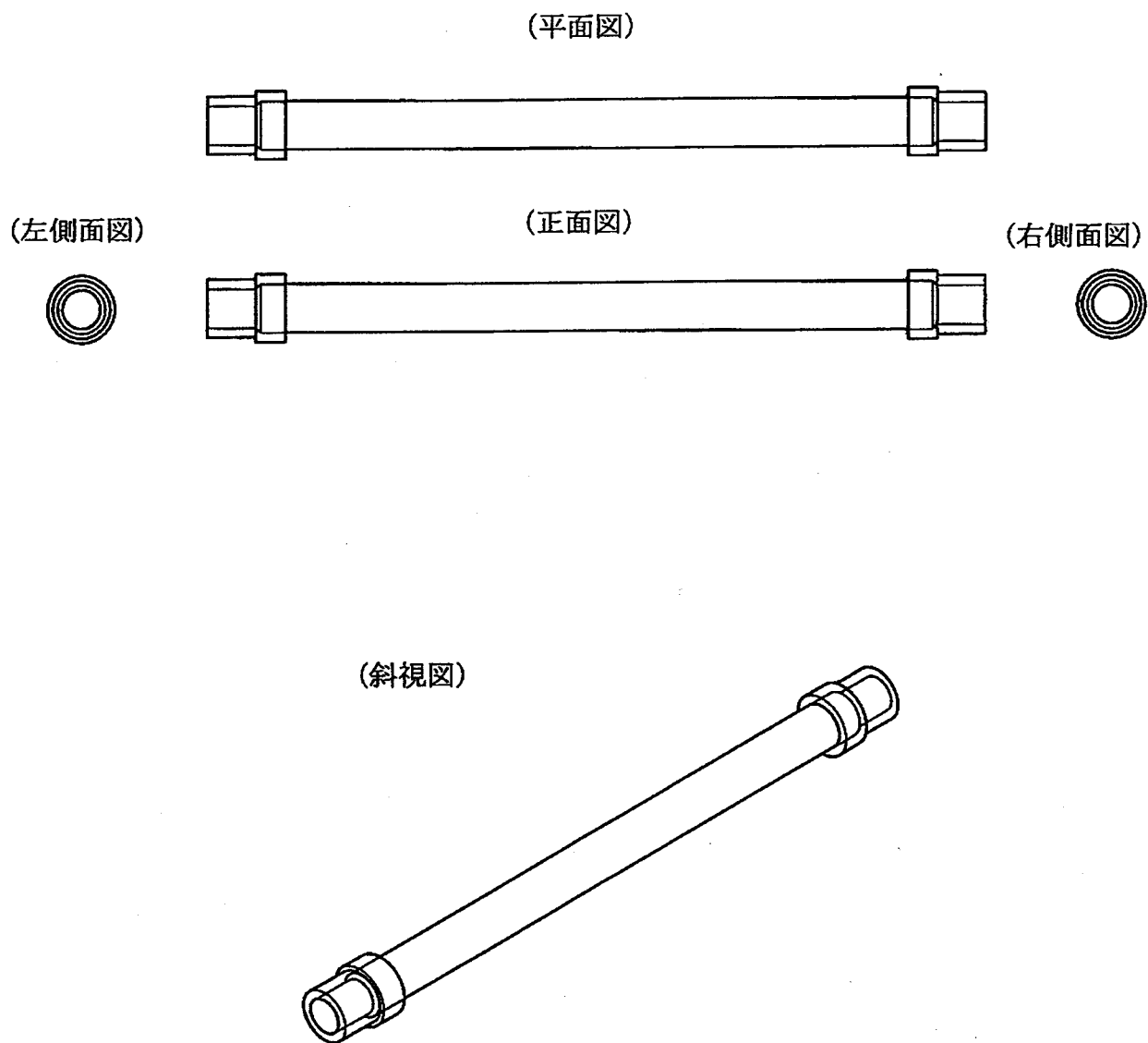

## 原告商品目録

商品名を「SCRATCH」と称する角質除去具であって、写真のと  
おりの形状を有するもの。

写真

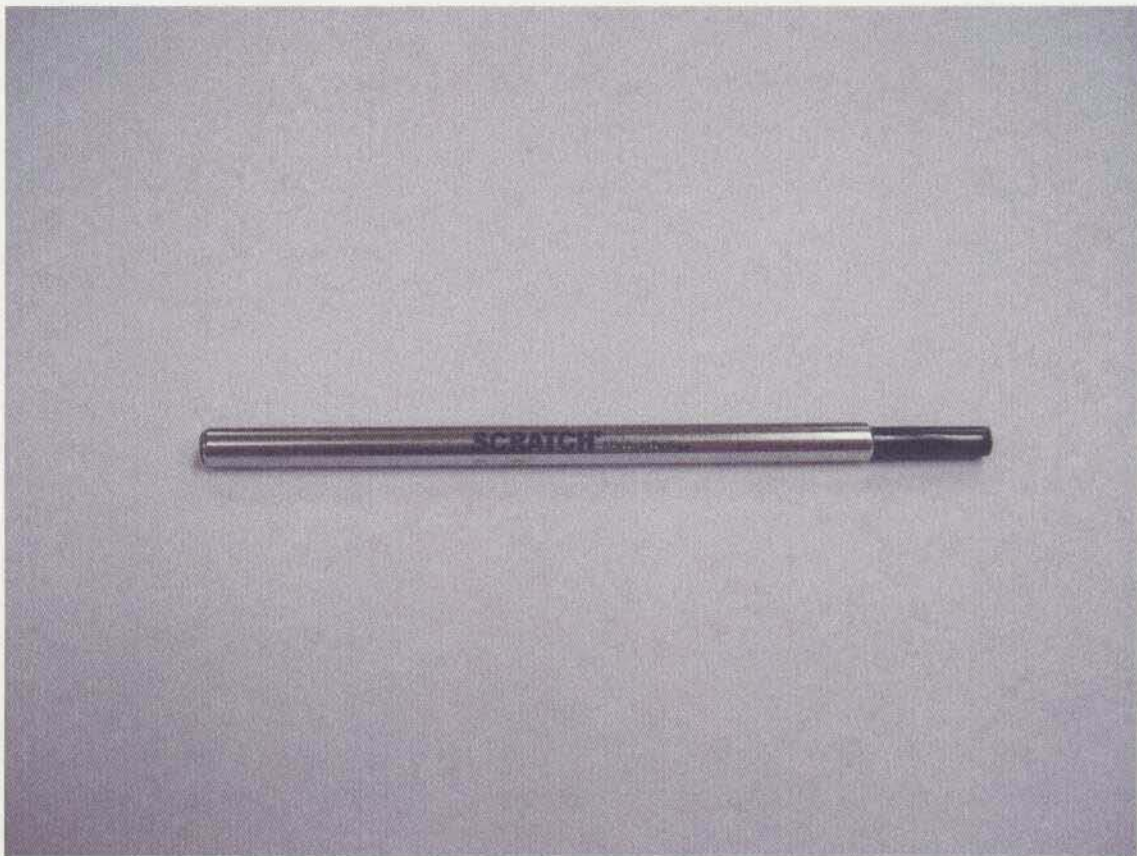

# 原告商品図面

図面1 (原告円筒管と原告スティックとが組み合わさった状態)

(平面図)

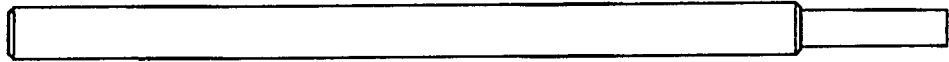

(左側面図)

(正面図)

(右側面図)



(斜視図)

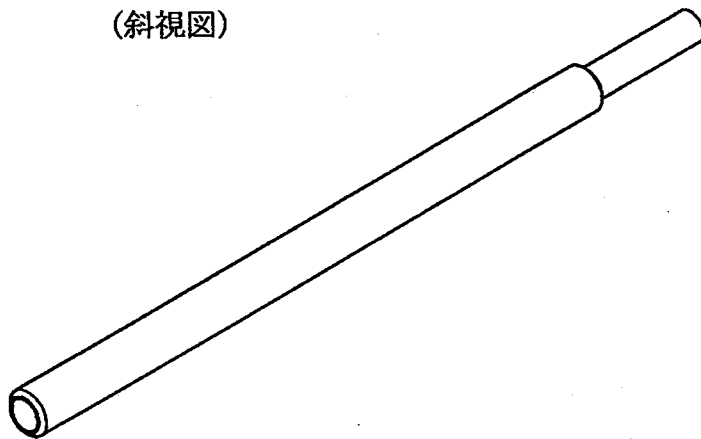

図面 2 (原告円筒管)

(平面図)



(側面図)



(正面図)



(斜視図)

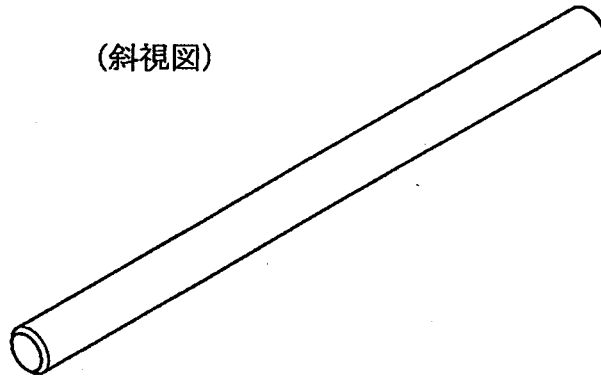

図面 3 (原告スティック)

(平面図)



(側面図)



(正面図)



(斜視図)

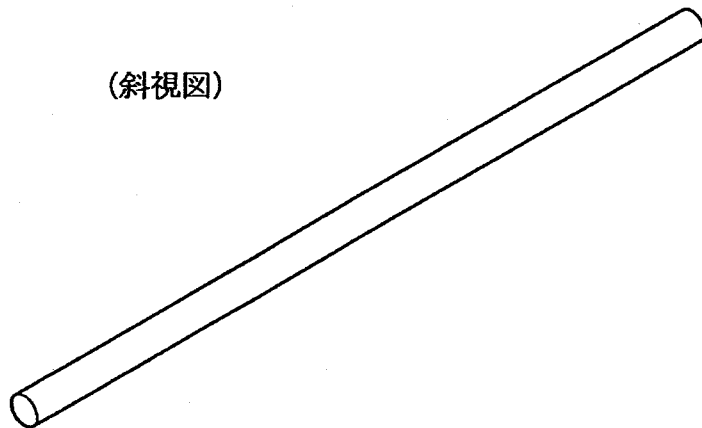



図面 4 (原告円筒管一刃先拡大図)

(正面図)

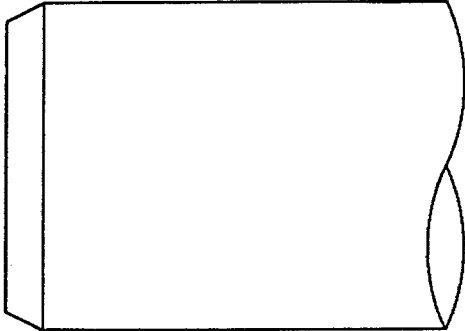

(正面図・断面図)

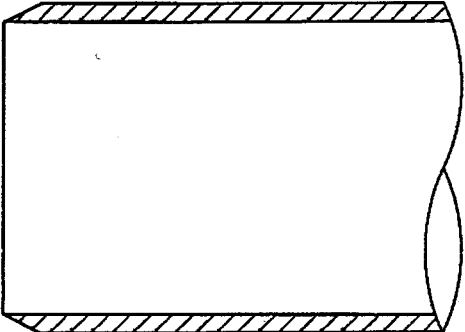

図面5 (原告商品のパッケージ内での収納状態)

(平面図)

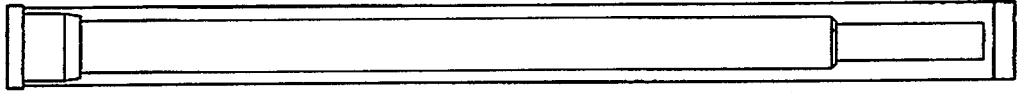

(左側面図)



(正面図)

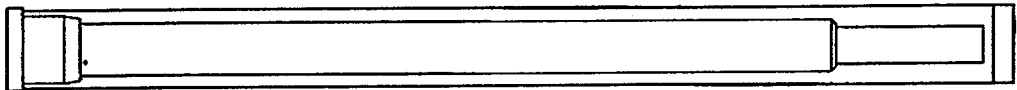

(右側面図)



(斜視図)

